

## PRODUCT FEATURES

- IGBT Chip(Trench+FS)
- Low saturation voltage and positive temperature coefficient
- Fast switching and short tail current
- Free wheeling diodes with fast and soft reverse recovery
- Temperature sense included



## APPLICATIONS

- AC motor control
- Motion/servo control
- Inverter and power supplies
- Photovoltaic/Fuel cell

### ABSOLUTE MAXIMUM RATINGS-IGBT ( $T_C=25^\circ\text{C}$ unless otherwise specified)

Symbol	Parameter/Test Conditions		Values	Unit
$V_{CES}$	Collector Emitter Voltage	$T_J=25^\circ\text{C}$	1200	V
$V_{GES}$	Gate Emitter Voltage		$\pm 20$	
$I_C$	DC Collector Current	$T_C=25^\circ\text{C}, T_{Jmax}=175^\circ\text{C}$	630	A
		$T_C=90^\circ\text{C}, T_{Jmax}=175^\circ\text{C}$	450	
$I_{CM}$	Repetitive Peak Collector Current	$t_p=1\text{ms}$	900	
$P_{tot}$	Power Dissipation Per IGBT	$T_C=25^\circ\text{C}, T_{Jmax}=175^\circ\text{C}$	2142	W

### ABSOLUTE MAXIMUM RATINGS-Diode ( $T_C=25^\circ\text{C}$ unless otherwise specified)

Symbol	Parameter/Test Conditions		Values	Unit
$V_{RRM}$	Repetitive Reverse Voltage	$T_J=25^\circ\text{C}$	1200	V
$I_{F(AV)}$	Average Forward Current		450	A
$I_{FRM}$	Repetitive Peak Forward Current	$t_p=1\text{ms}$	900	
$I^2t$		$T_J=150^\circ\text{C}, t=10\text{ms}, V_R=0\text{V}$	28500	$\text{A}^2\text{s}$

MacMic Science & Technology Co., Ltd.

Add: #18, Hua Shan Zhong Lu, New District, Changzhou City, Jiangsu Province, P. R. of China

Tel.: +86-519-85163708 Fax: +86-519-85162291 Post Code: 213022 Website: www.macmicst.com

# MMG450WE120B6TC

## ELECTRICAL CHARACTERISTICS-IGBT ( $T_C=25^\circ\text{C}$ unless otherwise specified)

Symbol	Parameter/Test Conditions		Min.	Typ.	Max.	Unit
$V_{GE(th)}$	Gate Emitter Threshold Voltage	$V_{CE}=V_{GE}, I_C=17\text{mA}$	5.2	5.8	6.4	V
$V_{CE(sat)}$	Collector Emitter Saturation Voltage	$I_C=450\text{A}, V_{GE}=15\text{V}, T_J=25^\circ\text{C}$		1.85	2.35	
		$I_C=450\text{A}, V_{GE}=15\text{V}, T_J=125^\circ\text{C}$		2.15		
		$I_C=450\text{A}, V_{GE}=15\text{V}, T_J=150^\circ\text{C}$		2.2		
$I_{CES}$	Collector Leakage Current	$V_{CE}=1200\text{V}, V_{GE}=0\text{V}, T_J=25^\circ\text{C}$			3	mA
		$V_{CE}=1200\text{V}, V_{GE}=0\text{V}, T_J=150^\circ\text{C}$			10	mA
$I_{GES}$	Gate Leakage Current	$V_{CE}=0\text{V}, V_{GE}=\pm 15\text{V}, T_J=25^\circ\text{C}$	-400		400	nA
$R_{Gint}$	Integrated Gate Resistor			1.4		$\Omega$
$Q_g$	Gate Charge	$V_{CE}=600\text{V}, I_C=450\text{A}, V_{GE}=\pm 15\text{V}$		2.25		$\mu\text{C}$
$C_{ies}$	Input Capacitance	$V_{CE}=25\text{V}, V_{GE}=0\text{V}, f=1\text{MHz}$		31.5		nF
$C_{res}$	Reverse Transfer Capacitance				1.5	
$t_{d(on)}$	Turn on Delay Time	$V_{CC}=600\text{V}, I_C=450\text{A}$ $R_G=1.5\Omega,$	$T_J=25^\circ\text{C}$		100	ns
			$T_J=125^\circ\text{C}$		120	ns
			$T_J=150^\circ\text{C}$		130	ns
$t_r$	Rise Time	$V_{GE}=\pm 15\text{V},$ Inductive Load	$T_J=25^\circ\text{C}$		78	ns
			$T_J=125^\circ\text{C}$		86	ns
			$T_J=150^\circ\text{C}$		86	ns
$t_{d(off)}$	Turn off Delay Time	$V_{CC}=600\text{V}, I_C=450\text{A}$ $R_G=1.5\Omega,$	$T_J=25^\circ\text{C}$		550	ns
			$T_J=125^\circ\text{C}$		590	ns
			$T_J=150^\circ\text{C}$		610	ns
$t_f$	Fall Time	$V_{GE}=\pm 15\text{V},$ Inductive Load	$T_J=25^\circ\text{C}$		120	ns
			$T_J=125^\circ\text{C}$		200	ns
			$T_J=150^\circ\text{C}$		220	ns
$E_{on}$	Turn on Energy	$V_{CC}=600\text{V}, I_C=450\text{A}$ $R_G=1.5\Omega,$	$T_J=25^\circ\text{C}$		31	mJ
			$T_J=125^\circ\text{C}$		50	mJ
			$T_J=150^\circ\text{C}$		55	mJ
$E_{off}$	Turn off Energy	$V_{GE}=\pm 15\text{V},$ Inductive Load	$T_J=25^\circ\text{C}$		27	mJ
			$T_J=125^\circ\text{C}$		36	mJ
			$T_J=150^\circ\text{C}$		40	mJ
$I_{SC}$	Short Circuit Current	$tpsc \leq 10\mu\text{s}, V_{GE}=15\text{V}$ $T_J=150^\circ\text{C}, V_{CC}=800\text{V}$		1700		A
$R_{thJC}$	Junction to Case Thermal Resistance ( Per IGBT )				0.07	K/W

# MMG450WE120B6TC

## ELECTRICAL CHARACTERISTICS-Diode ( $T_C=25^\circ\text{C}$ unless otherwise specified)

Symbol	Parameter/Test Conditions		Min.	Typ.	Max.	Unit
$V_F$	Forward Voltage	$I_F=450\text{A}, V_{GE}=0\text{V}, T_J=25^\circ\text{C}$		1.8	2.3	V
		$I_F=450\text{A}, V_{GE}=0\text{V}, T_J=125^\circ\text{C}$		1.55		
		$I_F=450\text{A}, V_{GE}=0\text{V}, T_J=150^\circ\text{C}$		1.5		
$I_{RRM}$	Max. Reverse Recovery Current	$I_F=450\text{A}, V_R=600\text{V}$		470		A
$Q_{RR}$	Reverse Recovery Charge	$di_F/dt=-5250\text{A}/\mu\text{s}$		93		$\mu\text{C}$
$E_{rec}$	Reverse Recovery Energy	$T_J=150^\circ\text{C}$		37.5		mJ
$R_{thJCD}$	Junction to Case Thermal Resistance (Per Diode)				0.12	K/W

## NTC CHARACTERISTICS ( $T_C=25^\circ\text{C}$ unless otherwise specified)

Symbol	Parameter/Test Conditions		Min.	Typ.	Max.	Unit
$R_{25}$	Resistance	$T_C=25^\circ\text{C}$		5		$\text{K}\Omega$
$B_{25/50}$	$R_2 = R_{25} \exp [B_{25/50}(1/T_2 - 1/(298.15 \text{ K}))]$			3375		K

## MODULE CHARACTERISTICS ( $T_C=25^\circ\text{C}$ unless otherwise specified)

Symbol	Parameter/Test Conditions		Values	Unit
$T_{Jmax}$	Max. Junction Temperature		175	$^\circ\text{C}$
$T_{Jop}$	Operating Temperature		-40~150	
$T_{stg}$	Storage Temperature		-40~125	
$V_{isol}$	Isolation Breakdown Voltage	AC, 50Hz(R.M.S), t=1minute	3000	V
CTI	Comparative Tracking Index		> 225	
Torque	to heatsink	Recommended (M5)	2.5~5	Nm
	to terminal	Recommended (M6)	3~5	Nm
Weight			350	g

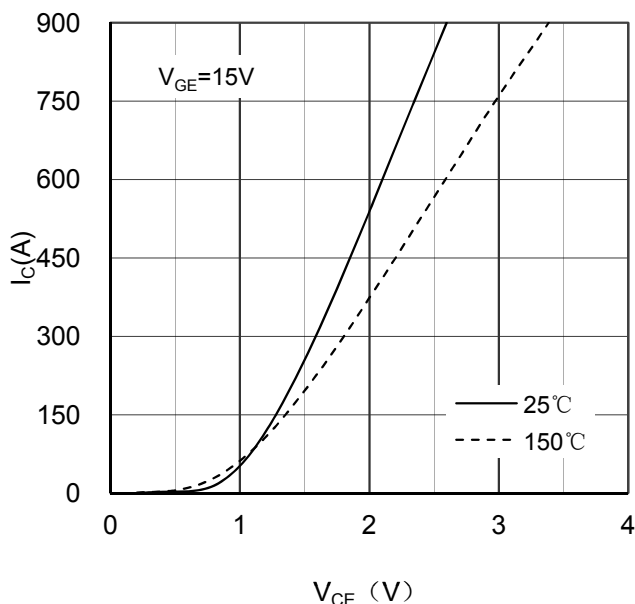

Figure 1. Typical Output Characteristics IGBT

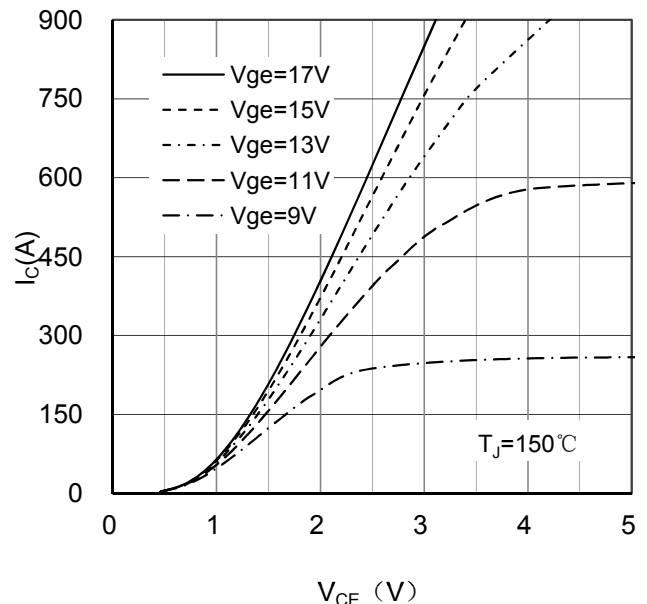

Figure 2. Typical Output Characteristics IGBT

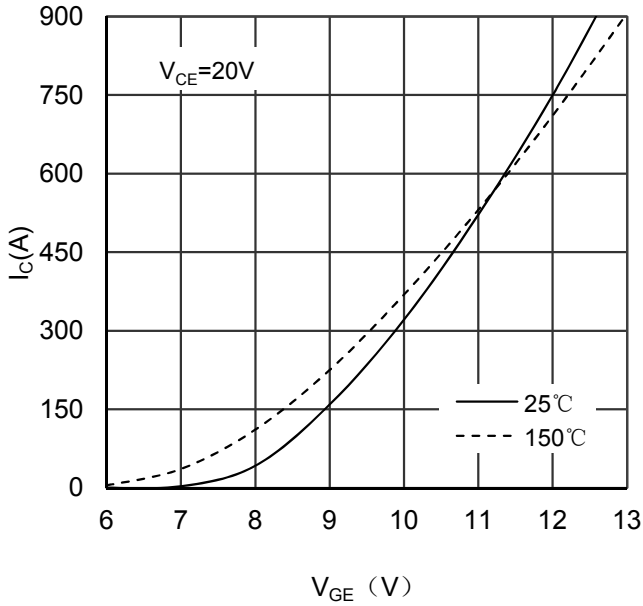

Figure 3. Typical Transfer characteristics IGBT

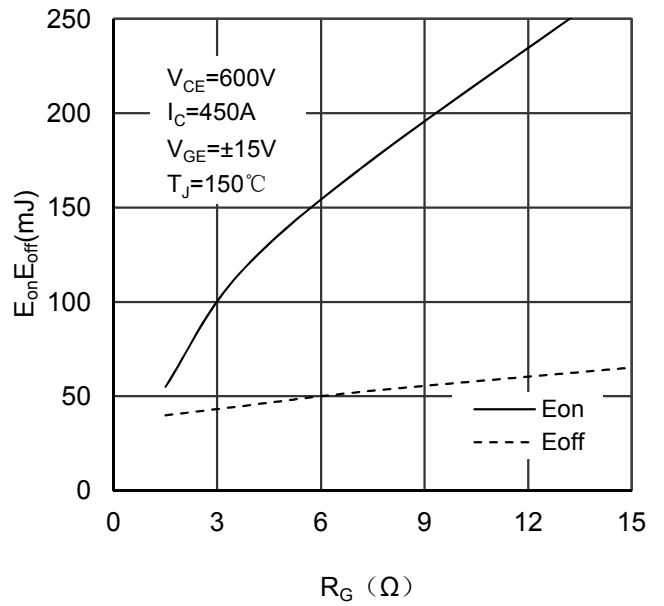

Figure 4. Switching Energy vs Gate Resistor IGBT

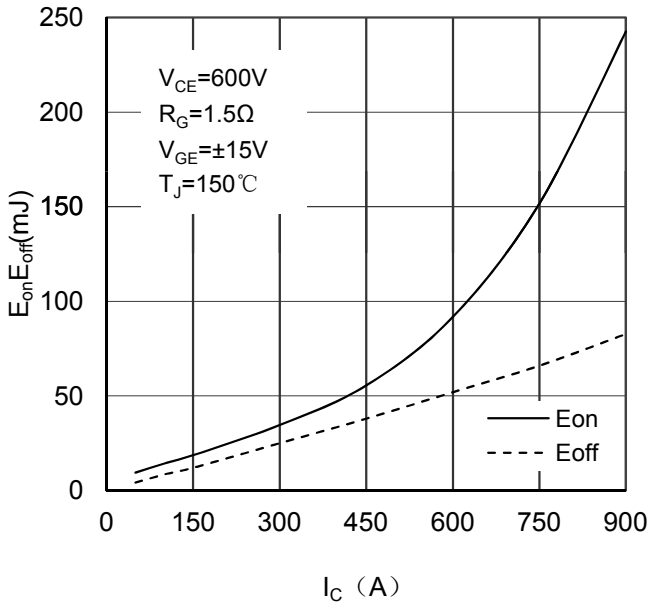

Figure 5. Switching Energy vs Collector Current IGBT

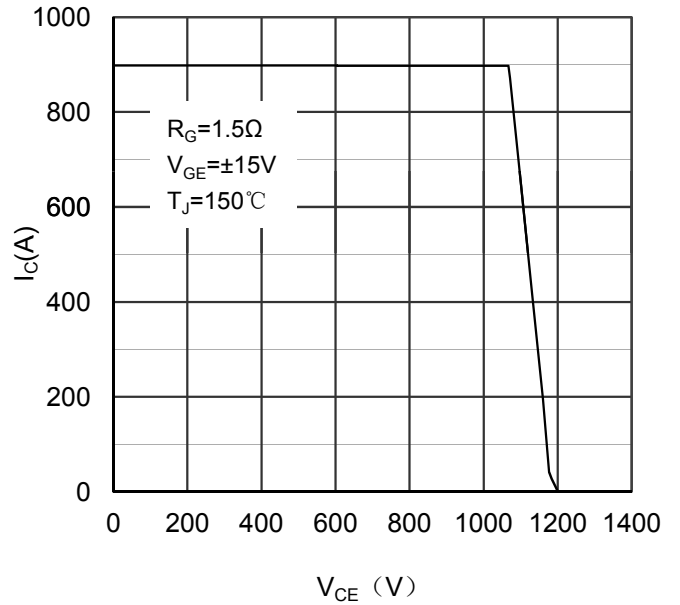

Figure 6. Reverse Biased Safe Operating Area IGBT

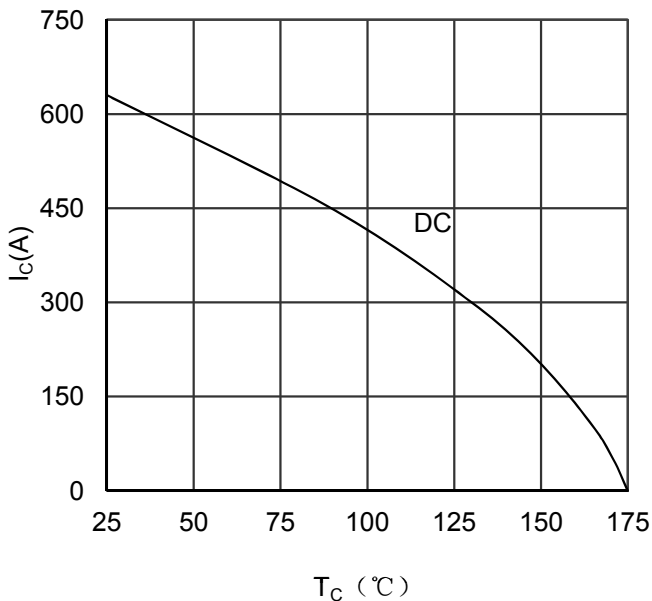

Figure 7. Collector Current vs Case temperature IGBT

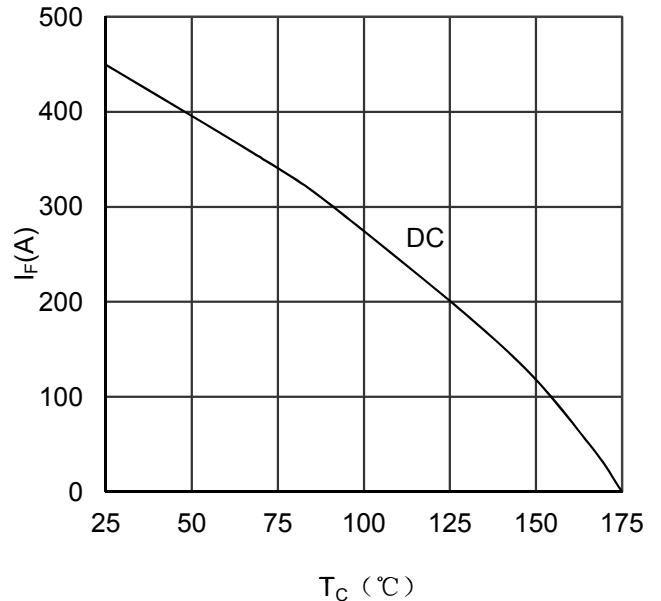

Figure 8. Forward current vs Case temperature Diode

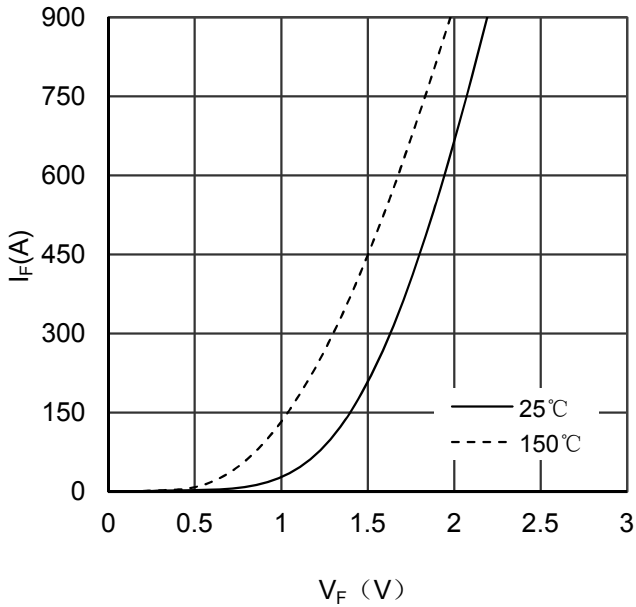

Figure 9. Diode Forward Characteristics Diode

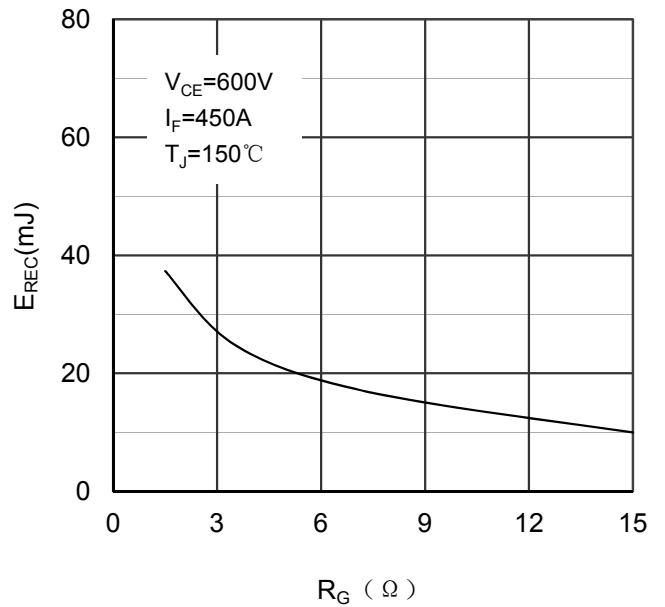

Figure 10. Switching Energy vs Gate Resistor Diode

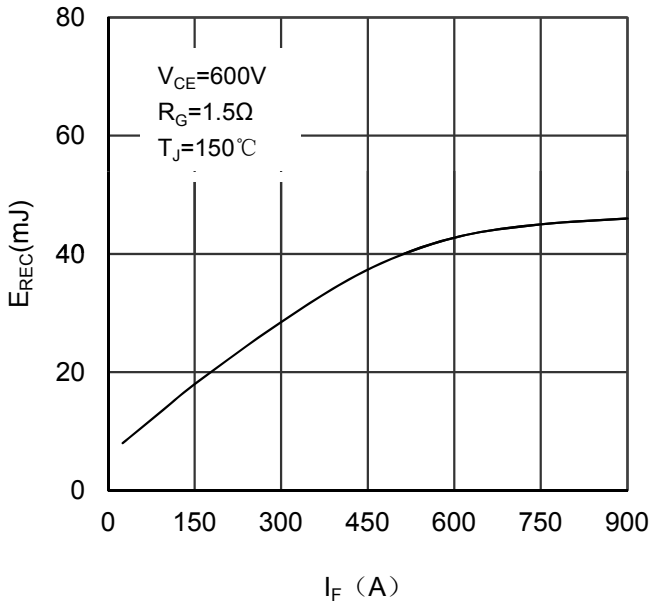

Figure 11. Switching Energy vs Forward Current Diode

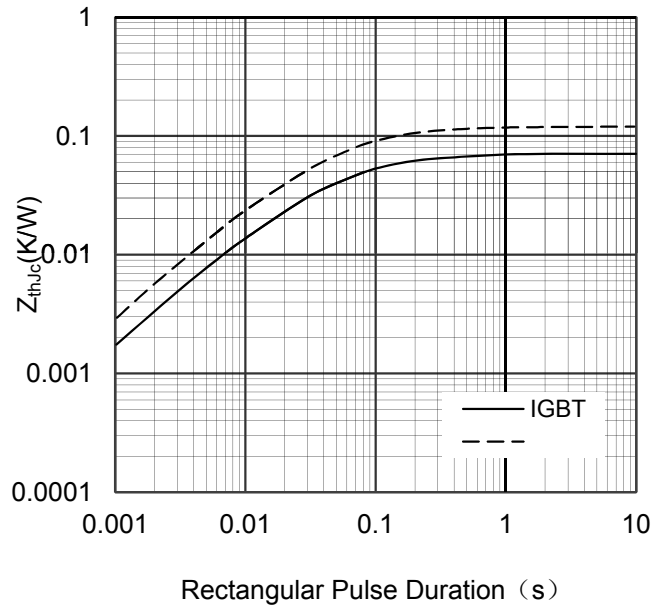

Figure 12. Transient Thermal Impedance of Diode and IGBT

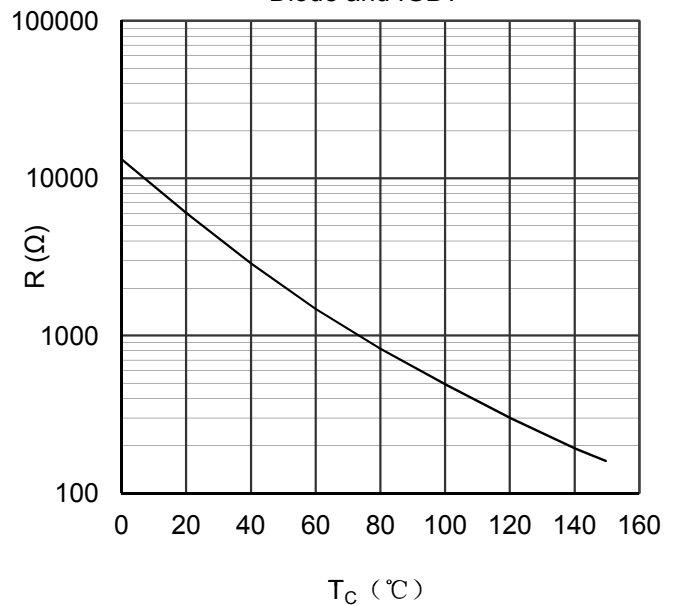

Figure 13. NTC Characteristics

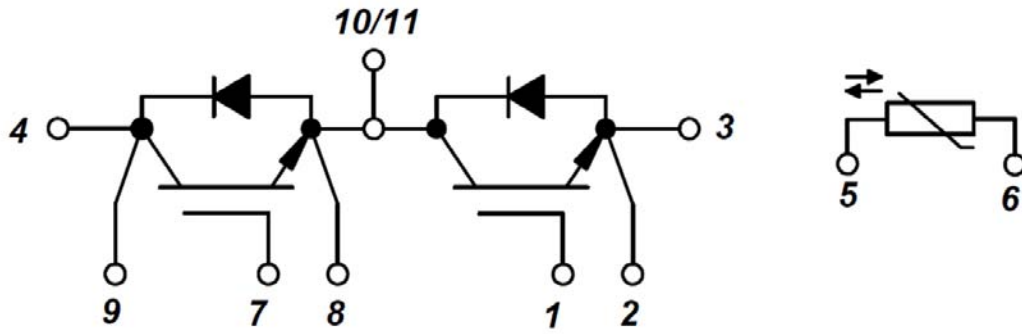
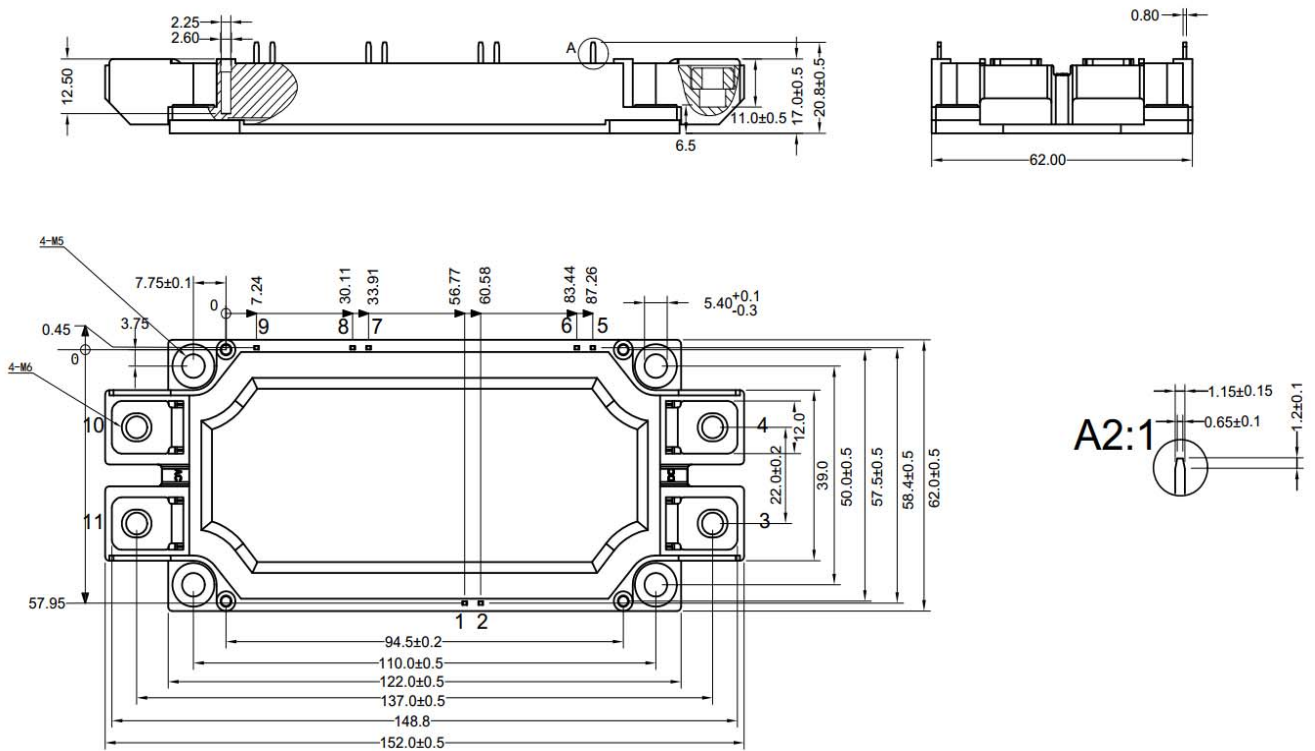

Figure 14. Circuit Diagram



Dimensions in (mm)

Figure 15. Package Outline